





2" DECORATIVE TRAVERSE ROD

BUCKINGHAM® & ESTATE ULTRA™ COLLECTIONS

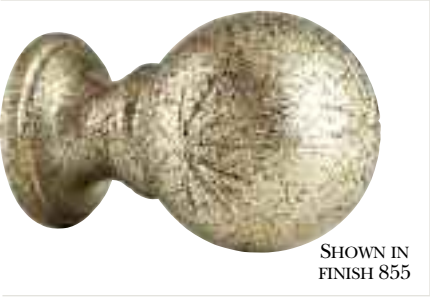

BUCKINGHAM® COLLECTION

Decorative Hardware Finials

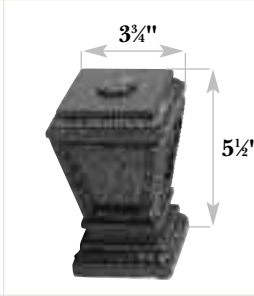
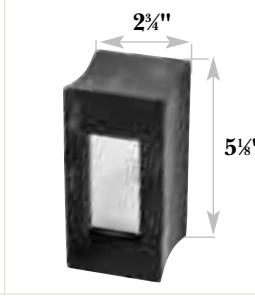
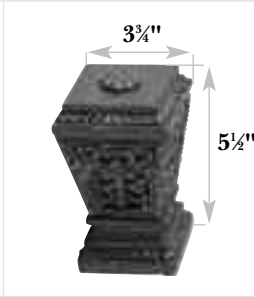
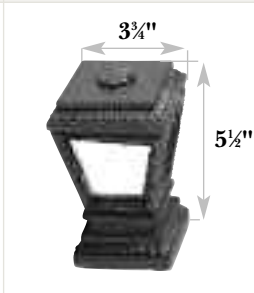

<p>Starlight</p> <p>CWB101</p>	<p>FINIAL DIMENSIONS 4¼"W x 3½"H x 3½"D</p>	<p>Lantern with Antique Mirror and Filigree</p> <p>CWB105</p>	<p>FINIAL DIMENSIONS 5½"W x 3¾"H x 3¾"D</p>
 <p>SHOWN IN FINISH 855</p>		 <p>SHOWN IN FINISH 857</p>	
<p>Lantern in Leather</p> <p>CWB102</p>	<p>FINIAL DIMENSIONS 5½"W x 3¾"H x 3¾"D</p>	<p>Sophisticate</p> <p>CWB106</p>	<p>FINIAL DIMENSIONS 5½"W x 2¾"H x 2¾"D</p>
 <p>SHOWN IN FINISH 857</p>		 <p>SHOWN IN FINISH 863</p>	
<p>Lantern in Leather with Filigree</p> <p>CWB103</p>	<p>FINIAL DIMENSIONS 5½"W x 3¾"H x 3¾"D</p>	<p>Twisted Ball</p> <p>CWB107</p>	<p>FINIAL DIMENSIONS 5¾"W x 3½"H x 3½"D</p>
 <p>SHOWN IN FINISH 857</p>		 <p>SHOWN IN FINISH 794</p>	
<p>Lantern with Antique Mirror Panels</p> <p>CWB104</p>	<p>FINIAL DIMENSIONS 5½"W x 3¾"H x 3¾"D</p>	<p>Swirl</p> <p>CWB108</p>	<p>FINIAL DIMENSIONS 8"W x 5½"H x 3"D</p>
 <p>SHOWN IN FINISH 857</p>		 <p>SHOWN IN FINISH 859</p>	



The Buckingham® Collection includes the following finishes: 700 Rustic Tortoise, 701 Aged Gold, 794 Brandywine, 856 Dark Walnut, 857 New Mahogany, 858 New Oak, 859 Crackle, 860 Wicker, 861 White Cloud, 862 Red Gold, 863 Black Mocha, 091 Unfinished

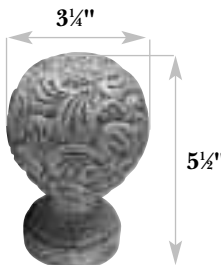

Premium Finishes: 855 Shimmer, 864 Gold Leaf

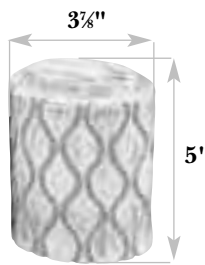

BUCKINGHAM® COLLECTION

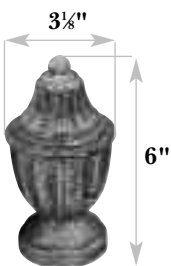

Decorative Hardware Finials

<p>FINIAL DIMENSIONS 5½"W x 3¾"H x 3¼"D</p> 	<p>Paisley Ball</p> <p>CWB109</p>  <p>SHOWN IN FINISH 860</p>
---	--

<p>FINIAL DIMENSIONS 5"W x 3¾"H x 2½"D</p> 	<p>Waves</p> <p>CWB113</p>  <p>SHOWN IN FINISH 861</p>
---	---



<p>FINIAL DIMENSIONS 6"W x 3¾"H x 3¾"D</p> 	<p>Sleek Urn</p> <p>CWB110</p>  <p>SHOWN IN FINISH 864</p>
--	---

<p>FINIAL DIMENSIONS 7"W x 3"H x 3"D</p> 	<p>Leaf Lamp</p> <p>CWB114</p>  <p>SHOWN IN SPECIALTY FINISH 861</p>
---	---

<p>FINIAL DIMENSIONS 7"W x 3"H x 3"D</p> 	<p>Folded Leaf</p> <p>CWB111</p>  <p>SHOWN IN FINISH 857</p>
--	---

 <p>SHOWN IN FINISH 869</p>
--

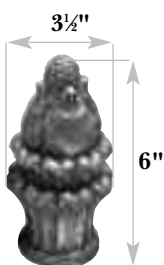
<p>FINIAL DIMENSIONS 7"W x 3"H x 3"D</p> 	<p>Traditional Rope</p> <p>CWB112</p>  <p>SHOWN IN FINISH 858</p>
--	--

<p>FINIAL DIMENSIONS 6"W x 3¾"H x 3¾"D</p> 	<p>Acanthus</p> <p>CWB201</p>  <p>SHOWN IN FINISH 701</p>
---	--

The Buckingham® Collection includes the following finishes: 700 Rustic Tortoise, 701 Aged Gold, 794 Brandywine, 856 Dark Walnut, 857 New Mahogany, 858 New Oak, 859 Crackle, 860 Wicker, 861 White Cloud, 862 Red Gold, 863 Black Mocha, 091 Unfinished

Premium Finishes: 855 Shimmer, 864 Gold Leaf

Specialty Contrast Finishes – 2" Finial Only: 869 Dark Walnut/Red Gold (Leaf Lamp finial only)

BUCKINGHAM® COLLECTION

Decorative Hardware Finials

<p>Pine Cone</p> <p>CWB203</p>	<p>FINIAL DIMENSIONS 6"W x 3"H x 3"D</p>
 <p>SHOWN IN FINISH 856</p>	

<p>Onion Dome</p> <p>CWB222</p>	<p>FINIAL DIMENSIONS 5½"W x 4½"H x 4½"D</p>
 <p>SHOWN IN FINISH 860</p>	

<p>Windsor</p> <p>CWB208</p>	<p>FINIAL DIMENSIONS 7½"W x 4"H x 4"D</p>
 <p>SHOWN IN FINISH 857</p>  <p>SHOWN IN SPECIALTY FINISH 868</p>	

<p>Leaf Dance</p> <p>CWB223</p>	<p>FINIAL DIMENSIONS 7½"W x 6"H x 2½"D</p>
 <p>SHOWN IN FINISH 861</p>	

<p>Cone Flower</p> <p>CWB224</p>	<p>FINIAL DIMENSIONS 5¾"W x 3¾"H x 3¾"D</p>
 <p>SHOWN IN FINISH 859</p>	

<p>Fleur de Lis</p> <p>CWB215</p>	<p>FINIAL DIMENSIONS 7½"W x 5¾"H x 2½"D</p>
 <p>SHOWN IN FINISH 859</p>	

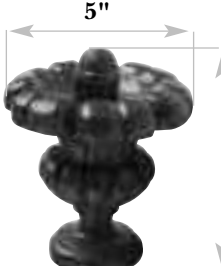
<p>Flower Urn</p> <p>CWB225</p>	<p>FINIAL DIMENSIONS 7"W x 5"H x 5"D</p>
 <p>SHOWN IN FINISH 700</p>	



The Buckingham® Collection includes the following finishes: 700 Rustic Tortoise, 701 Aged Gold, 794 Brandywine, 856 Dark Walnut, 857 New Mahogany, 858 New Oak, 859 Crackle, 860 Wicker, 861 White Cloud, 862 Red Gold, 863 Black Mocha, 091 Unfinished

Premium Finishes: 855 Shimmer, 864 Gold Leaf

Specialty Contrast Finishes – 2" Finial Only: 868 Dark Walnut/Black (Windsor finial only)



BUCKINGHAM® COLLECTION



Decorative Hardware Finials



<p>FINIAL DIMENSIONS 7"W x 3½"H x 3¼"D</p> 	<p>Pineacanthus CWB228</p>  <p>SHOWN IN FINISH 701</p>
--	--

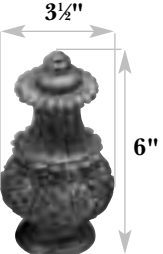

<p>FINIAL DIMENSIONS 6"W x 4"H x 4"D</p> 	<p>Cross Geometric CWB903</p>  <p>SHOWN IN FINISH 856</p>
---	---

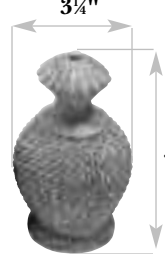

<p>FINIAL DIMENSIONS 5¼"W x 3¾"H x 3¾"D</p> 	<p>Wood Ball CWB559</p>  <p>SHOWN IN FINISH 862</p>
---	---

<p>SHOWN IN FINISH 870</p> 	<p>SHOWN IN FINISH 871</p> 
--	--

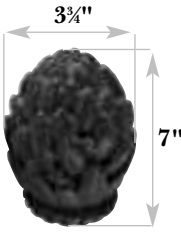
<p>FINIAL DIMENSIONS 6"W x 3½"H x 3¼"D</p> 	<p>Empress CWB900</p>  <p>SHOWN IN FINISH 701</p>
--	---

<p>FINIAL DIMENSIONS 5"W x 3¾"H x 3¾"D</p> 	<p>Hobnail CWB906</p>  <p>SHOWN IN FINISH 860</p>
---	---

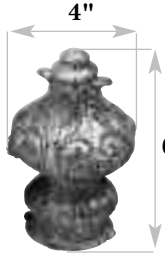
<p>FINIAL DIMENSIONS 7"W x 3¾"H x 3¾"D</p> 	<p>Artichoke CWB905</p>  <p>SHOWN IN SPECIALTY FINISH 857</p>
--	---

<p>FINIAL DIMENSIONS 6½"W x 4"H x 4"D</p> 	<p>Regal CWB908</p>  <p>SHOWN IN FINISH 864</p>
--	---

The Buckingham® Collection includes the following finishes: 700 Rustic Tortoise, 701 Aged Gold, 794 Brandywine, 856 Dark Walnut, 857 New Mahogany, 858 New Oak, 859 Crackle, 860 Wicker, 861 White Cloud, 862 Red Gold, 863 Black Mocha, 091 Unfinished

Premium Finishes: 855 Shimmer, 864 Gold Leaf

Specialty Contrast Finishes – 2" Finial Only: 870 Shimmer/Black (Cross Geometric finial only), 871 Black/Shimmer (Cross Geometric finial only)

BUCKINGHAM® COLLECTION

Decorative Hardware Endcaps

<p>Fluted</p> <p>CWB701</p>	<p>FINIAL DIMENSIONS 1½"W x 2½"H x 2½"D</p>
 <p>SHOWN IN FINISH 856</p>	

<p>Cross Geometric</p> <p>CWB940</p>	<p>FINIAL DIMENSIONS 1¼"W x 2¾"H x 2¾"D</p>
 <p>SHOWN IN FINISH 855</p>	

<p>Rope</p> <p>CWB930</p>	<p>FINIAL DIMENSIONS 1¼"W x 2½"H x 2½"D</p>
 <p>SHOWN IN FINISH 701</p>	

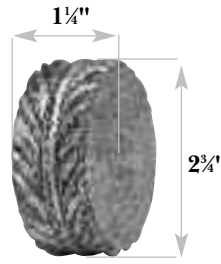
<p>Leaf Lamp</p> <p>CWB941</p>	<p>FINIAL DIMENSIONS 1¼"W x 2¾"H x 2¾"D</p>
 <p>SHOWN IN FINISH 864</p>	



Featured here: Kirsch® Estate Ultra™ hardware featuring the Lantern finial in Dark Walnut.

The Buckingham® Collection includes the following finishes: 700 Rustic Tortoise, 701 Aged Gold, 794 Brandywine, 856 Dark Walnut, 857 New Mahogany, 858 New Oak, 859 Crackle, 860 Wicker, 861 White Cloud, 862 Red Gold, 863 Black Mocha, 091 Unfinished

Premium Finishes: 855 Shimmer, 864 Gold Leaf

BUCKINGHAM® COLLECTION

Assembled Rod Sets & Finishes

Assembled Set with Rings

93670



SHOWN IN
FINISH 700

BRACKETS INCLUDED
1 3/4" - 3 3/4" CLEARANCE

Rings are "C" rings, see picture of part #5530 below. 3 Slides or rings per foot, if additional slides are needed, must order separately at the time of order. Assembled sets do not come with finials, they must be ordered separately.

Assembled Set without Rings

93675



SHOWN IN
FINISH 858

BRACKETS INCLUDED
1 3/4" - 3 3/4" CLEARANCE

Assembled Set with Ripplefold

93676



SHOWN IN
FINISH 701

BRACKETS INCLUDED
1 3/4" - 3 3/4" CLEARANCE

Rings for Buckingham Finishes

5530



SHOWN IN
FINISH 700

Slide sold separately

Ball Bearing Slide

9680



AVAILABLE IN
FINISH 025

**All Fascias are 2" high.
Minimum width 3'.
Maximum width 16'.**

The Buckingham® Collection includes the following finishes: 700 Rustic Tortoise, 701 Aged Gold, 794 Brandywine, 856 Dark Walnut, 857 New Mahogany, 858 New Oak, 859 Crackle, 860 Wicker, 861 White Cloud, 862 Red Gold, 863 Black Mocha, 091 Unfinished

Premium Finishes: 855 Shimmer, 864 Gold Leaf

ESTATE ULTRA™ WOOD COLLECTION

Finishes

700



701



794



855



856



857



858



859



860



861



862



863



864



Unfinished traverse rods are available. Please refer to the Estate Wood Trends Collection.



The Buckingham® Collection includes the following finishes: 700 Rustic Tortoise, 701 Aged Gold, 794 Brandywine, 856 Dark Walnut, 857 New Mahogany, 858 New Oak, 859 Crackle, 860 Wicker, 861 White Cloud, 862 Red Gold, 863 Black Mocha, 091 Unfinished



Premium Finishes: 855 Shimmer, 864 Gold Leaf

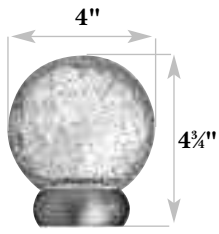
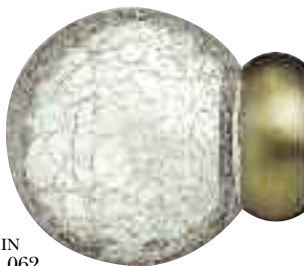

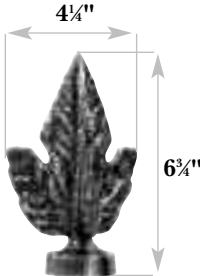
ESTATE ULTRA™ METAL COLLECTION

Finials and Assembled Rod Sets

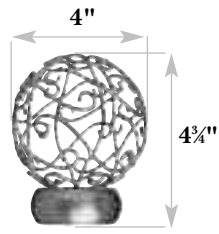
<p>FINIAL DIMENSIONS 4¾"W x 4"H x 4"D</p> 	<p>Cracked Glass</p> <p>50960</p>  <p>AVAILABLE IN FINISHES 012, 062</p>
---	---

<p>FINIAL DIMENSIONS 6¾"W x 4¼"H x 4¼"D</p> 	<p>Leaf</p> <p>50963</p>  <p>AVAILABLE IN FINISH 062</p>
--	---

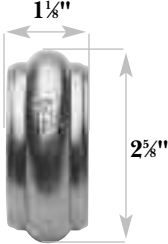
<p>FINIAL DIMENSIONS 4¾"W x 4"H x 4"D</p> 	<p>Scrolled Ball</p> <p>50962</p>  <p>AVAILABLE IN FINISH 012</p>
---	--

<p>FINIAL DIMENSIONS 1½"W x 2½"H x 2¾"D</p> 	<p>End Cap</p> <p>54801</p>  <p>SHOWN IN FINISH 012</p>
--	--

<p>Assembled Set with Rings</p> <p>93680</p> 	<p>SHOWN IN FINISH 012</p> <p>BRACKETS INCLUDED 1¼" - 3¾" CLEARANCE</p>
--	---

<p>Assembled Set without Rings</p> <p>93685</p> 	<p>SHOWN IN FINISH 110</p> <p>BRACKETS INCLUDED 1¼" - 3¾" CLEARANCE</p>
--	---

Rings are "C" rings, see picture of part #5530 below. 3 Slides or rings per foot, if additional slides are needed, must order separately at the time of order. Assembled sets do not come with finials, they must be ordered separately.

<p>Assembled Set with Ripplefold</p> <p>93686</p> 	<p>SHOWN IN FINISH 062</p> <p>BRACKETS INCLUDED 1¼" - 3¾" CLEARANCE</p>
---	---

All Fascias are 2" high.
Minimum width 3'.
Maximum width 16'.

The Estate Ultra™ Metal Collection includes the following finishes:
012 Satin Nickel, 062 Antique Brass, 110 Satin Brass

ESTATE ULTRA™ METAL COLLECTION

Slide, & Rings

Ball Bearing Slide

9680



AVAILABLE IN
FINISH 025

Rings

for Metal Finishes

5530



SHOWN IN
FINISH 012

Slide sold separately

Swivel Socket

54803



SHOWN IN
FINISH 110

SIZE:
6 1/4" W X 3 1/2" H X 3 1/8" D

*Maximum Width: 16'
All Rods are 2" in height.*

Finishes

All Fascias are 2" high. Minimum width 3'. Maximum width 16'.

012



062



110



*The Estate Ultra™ Metal Collection includes the following finishes:
012 Satin Nickel, 062 Antique Brass, 110 Satin Brass*

ESTATE ULTRA™ METAL COLLECTION

Brackets & Ordering Instructions

Extended Projection Wall Bracket

94125

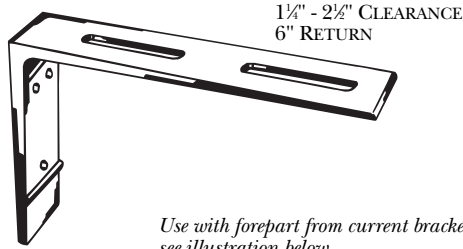

AVAILABLE IN FINISH
025 WHITE,
090 ALUMINUM

Use with forepart from current bracket,
see illustration below

Double Rod Bracket

71132

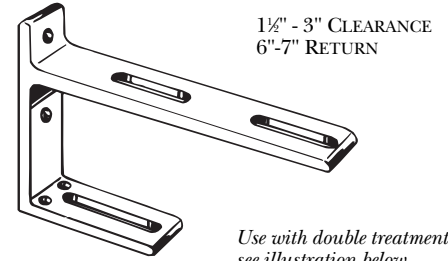

AVAILABLE IN FINISHES
006 BLACK,
012 SATIN NICKEL,
062 ANTIQUE BRASS,
086 OAK,
110 SATIN BRASS

Use with double treatments,
see illustration below



Standard Treatment

Double Treatment
with 71132 Bracket

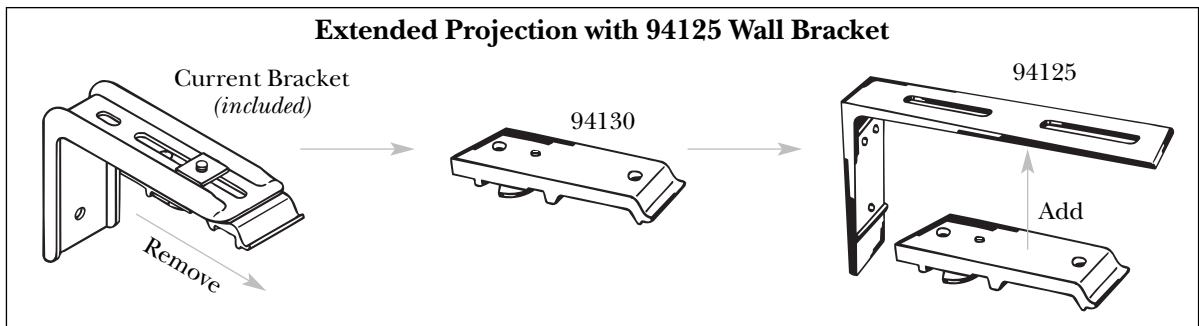
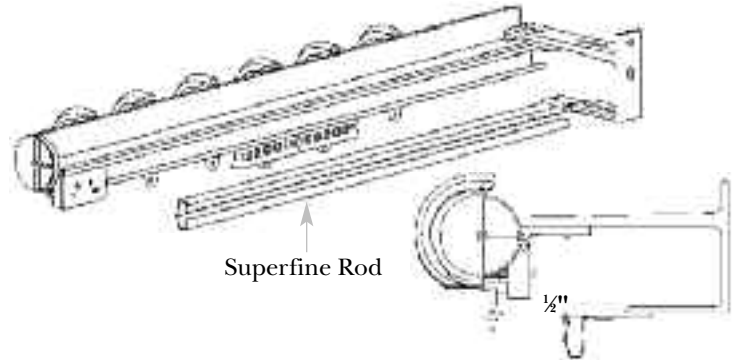
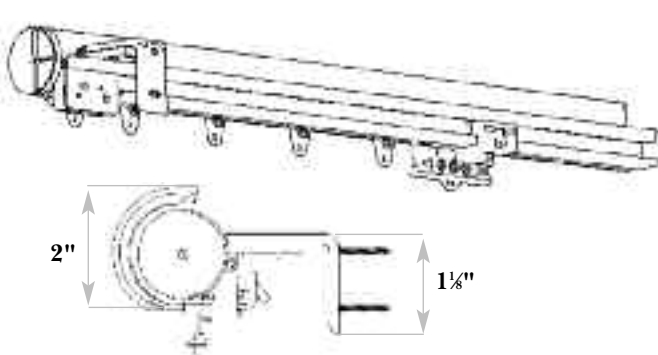

3 slides standard per foot, if additional slides are needed, must order separately at the time of order.

Ceiling Mount Bracket

(Bracket #1796.061 with part #94130)

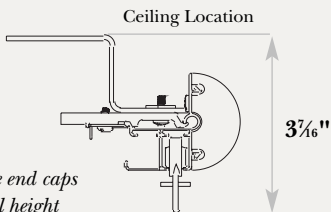

*Can only use end caps
due to finial height

HOW TO ORDER SETS

1. Specify quantity and set number, including finish.
2. Specify bracket to bracket measurement.
3. Specify center draw or one way. Indicate stack side for a one way draw.
4. Specify Cord Location (right or left) and cord drop (8' is standard).
5. Specify wall or ceiling mount* and return measurement.
6. Select finials or endcaps.

*If ceiling mount you can only use end caps due to finial height.



WWW.KIRSCH.COM

Discover other Kirsch Drapery Hardware Collections
available for all window covering needs and applications

Estate Ultra™
Estate Wood Trends™
Metal Accessories
Mix & Match®

Studio Coordinates®
Wrought Iron
Buckingham®

Kirsch Window Fashions ©2010
4110 Premier Drive, High Point, NC 27265
Phone: 1.800.225.1988 • Fax: 1.800.545.2325
www.kirsch.com

Newell Rubbermaid
Brands That Matter

Décor

Featured on the cover: Kirsch® Estate Ultra™ drapery hardware with the Sleek Urn finial from the Buckingham® Collection in the luxurious Gold Leaf finish.

Color photography in print may vary slightly from actual finished product. Please confirm your color selection with the Kirsch Swatch Card or Kirsch Display Board.

F0398009